

953

CREATED ON
2022-12-26

Total area 2640.98 sq ft	Floors 4	Rooms 26	Bathrooms 3
------------------------------------	--------------------	--------------------	-----------------------

▼ 1st Floor

TOTAL AREA: 817.47 sq ft • LIVING AREA: 731.36 sq ft • ROOMS: 5

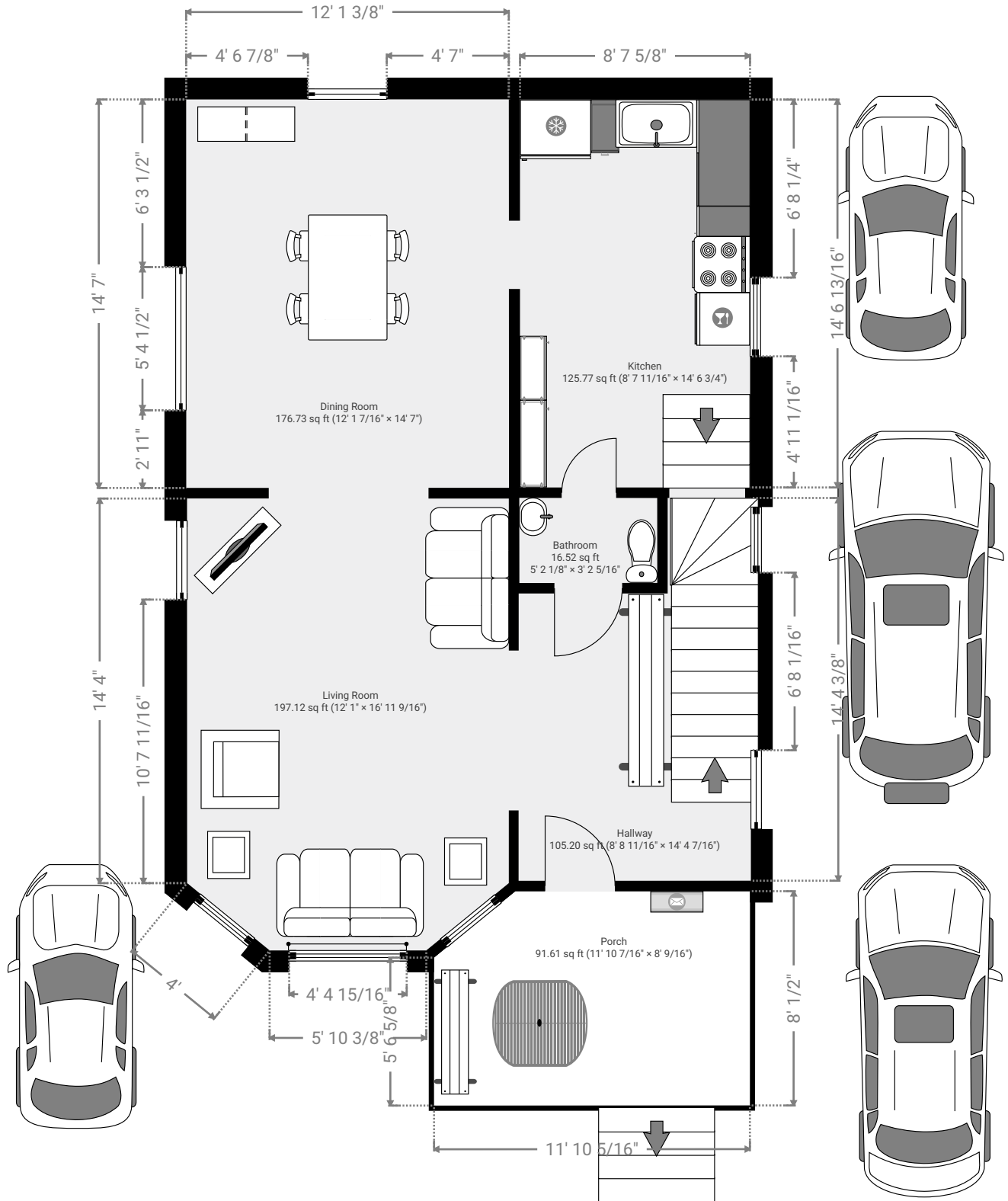

THIS FLOORPLAN IS PROVIDED WITHOUT WARRANTY OF ANY KIND. SENSOPIA DISCLAIMS ANY WARRANTY INCLUDING, WITHOUT LIMITATION, SATISFACTORY QUALITY OR ACCURACY OF DIMENSIONS.

0' 2' 4' 6' 8' 10' 1:66

▼ Bathroom
1st Floor

WIDTH: 5' 2 1/8" • LENGTH: 3' 2 5/16"
AREA: 16.52 sq ft • PERIMETER: 16' 8 13/16"

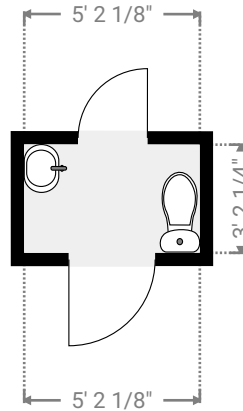
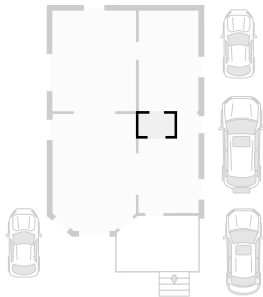

▼ Dining Room
1st Floor

WIDTH: 12' 1 7/16" • LENGTH: 14' 7"
AREA: 176.73 sq ft • PERIMETER: 53' 4 13/16"

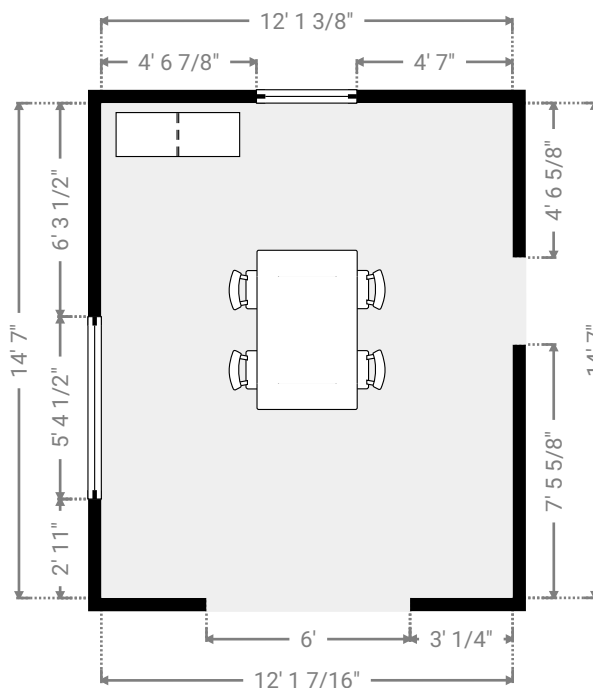
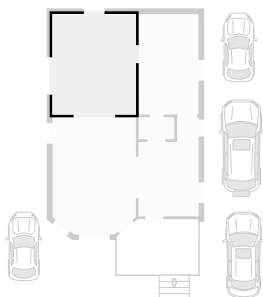

▼ **Hallway**
1st Floor

WIDTH: 8' 8 11/16" • LENGTH: 14' 4 7/16"
AREA: 105.20 sq ft • PERIMETER: 46' 2 1/8"

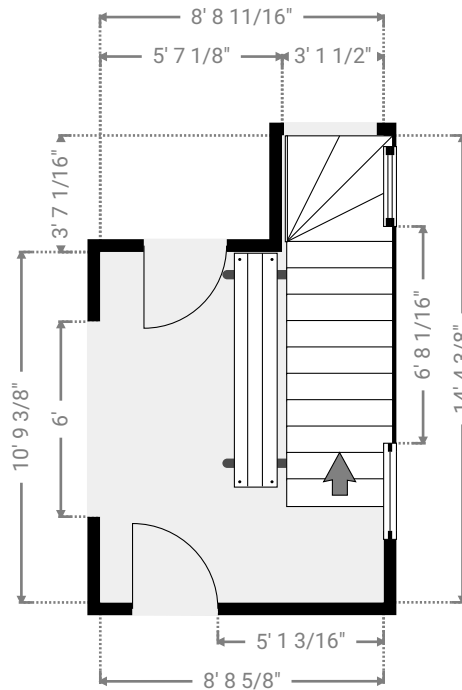
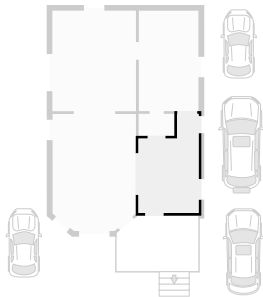

▼ **Kitchen**
1st Floor

WIDTH: 8' 7 11/16" • LENGTH: 14' 6 3/4"
AREA: 125.77 sq ft • PERIMETER: 46' 4 3/4"

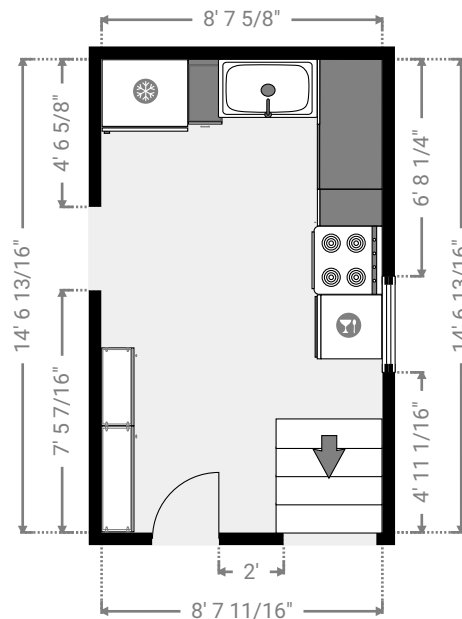
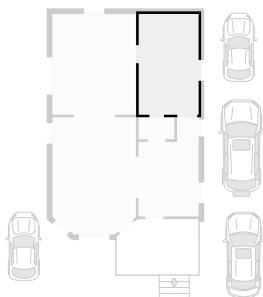

▼ Living Room
1st Floor

WIDTH: 12' 1" • LENGTH: 16' 11 9/16"
AREA: 197.12 sq ft • PERIMETER: 54' 10 1/16"

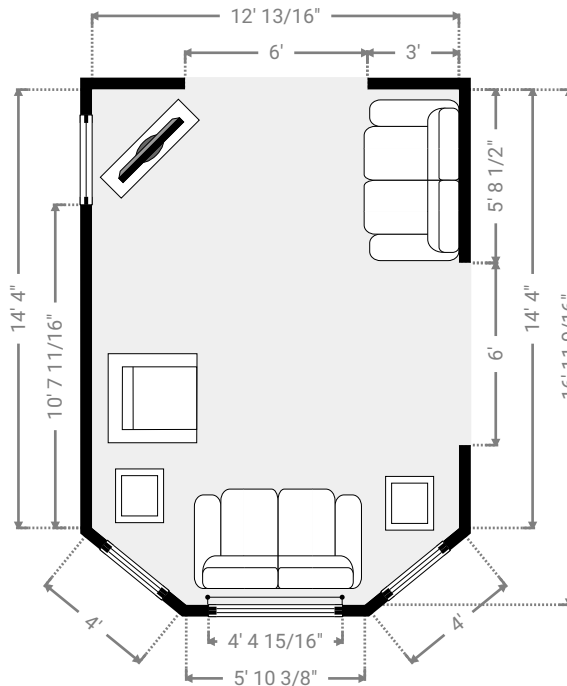
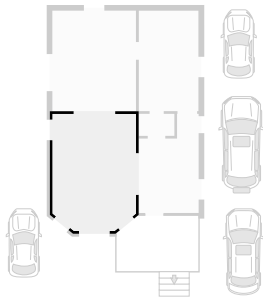

▼ Porch
1st Floor

WIDTH: 11' 10 7/16" • LENGTH: 8' 9/16"
AREA: 91.61 sq ft • PERIMETER: 38' 2 1/2"

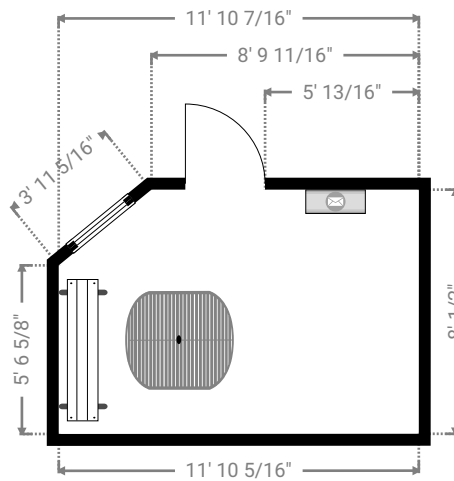
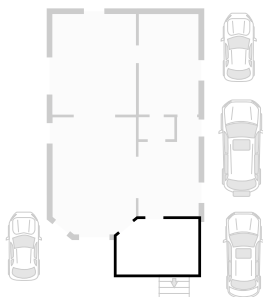

▼ Bathroom
2nd Floor

WIDTH: 8' 1/8" • LENGTH: 5'
AREA: 40.03 sq ft • PERIMETER: 26' 3/16"

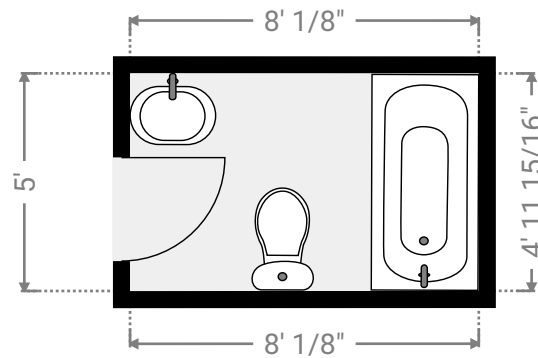
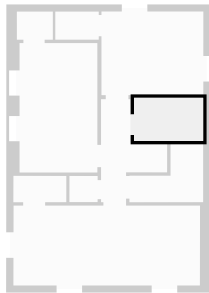

▼ Bedroom
2nd Floor

WIDTH: 11' 9 5/8" • LENGTH: 9' 8 1/4"
AREA: 114.30 sq ft • PERIMETER: 42' 11 11/16"

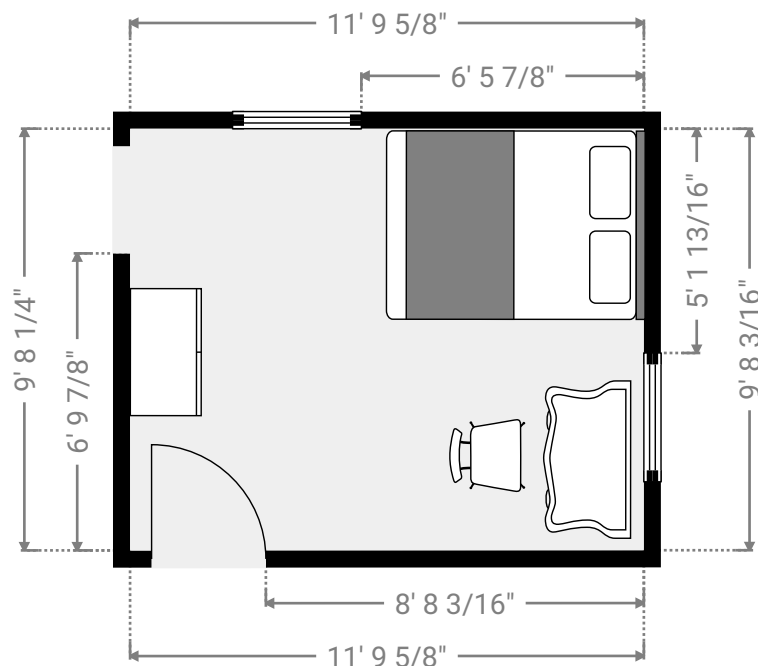
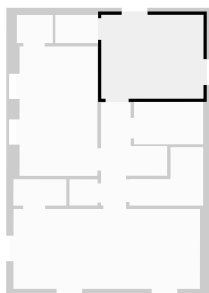

▼ **Closet**
2nd Floor

WIDTH: 5' 3/8" • LENGTH: 3' 3"
AREA: 16.35 sq ft • PERIMETER: 16' 6 3/4"

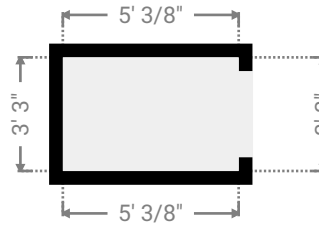

▼ **Bedroom**
2nd Floor

WIDTH: 9' 3/16" • LENGTH: 14' 11 7/8"
AREA: 135.10 sq ft • PERIMETER: 48' 1/16"

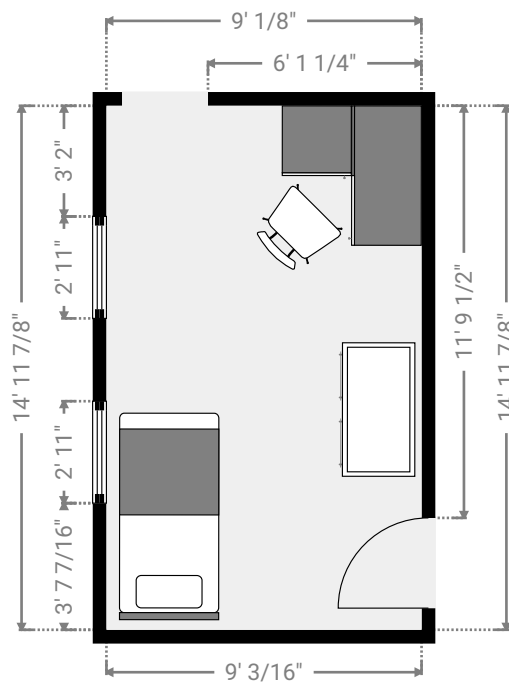
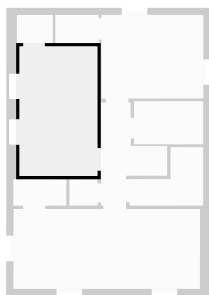

▼ **Closet**
2nd Floor

WIDTH: 4' 2" • LENGTH: 3' 3 1/16"
AREA: 13.55 sq ft • PERIMETER: 14' 10 1/16"

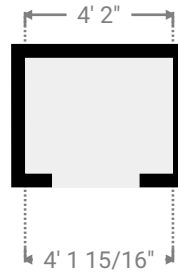
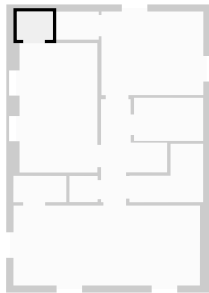

▼ **Bedroom**
2nd Floor

WIDTH: 21' 7 1/4" • LENGTH: 9' 3 7/16"
AREA: 199.82 sq ft • PERIMETER: 61' 8 7/16"

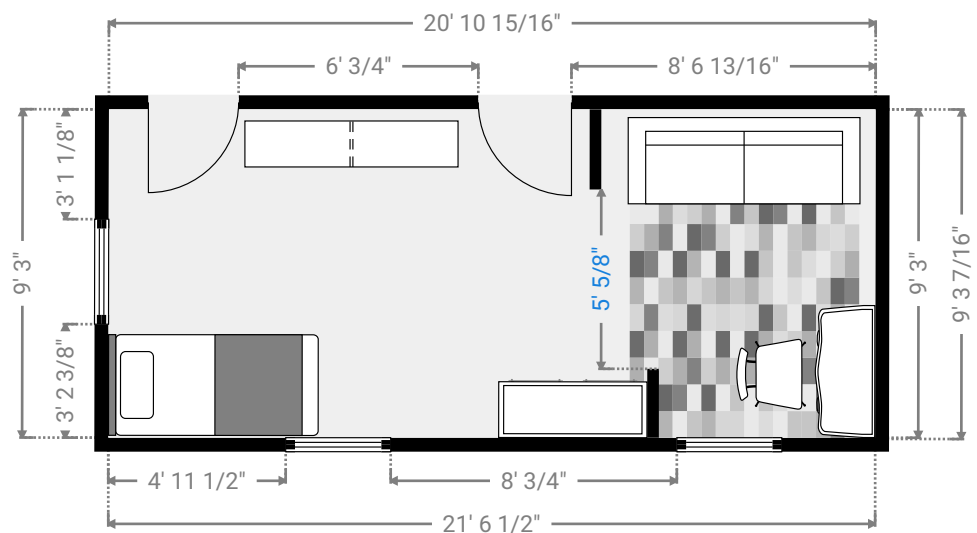
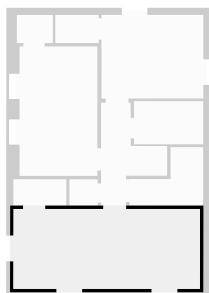

▼ **Closet**
2nd Floor

WIDTH: 6' 1 9/16" • LENGTH: 3' 3/4"
AREA: 18.71 sq ft • PERIMETER: 18' 4 3/8"

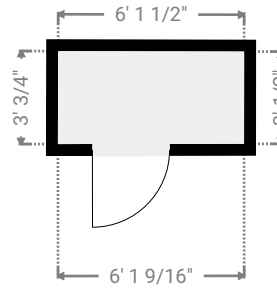
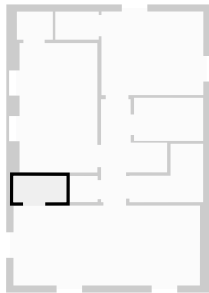

▼ **Hallway**
2nd Floor

WIDTH: 7' 8 1/8" • LENGTH: 11' 11 3/8"
AREA: 53.60 sq ft • PERIMETER: 39' 1 7/8"

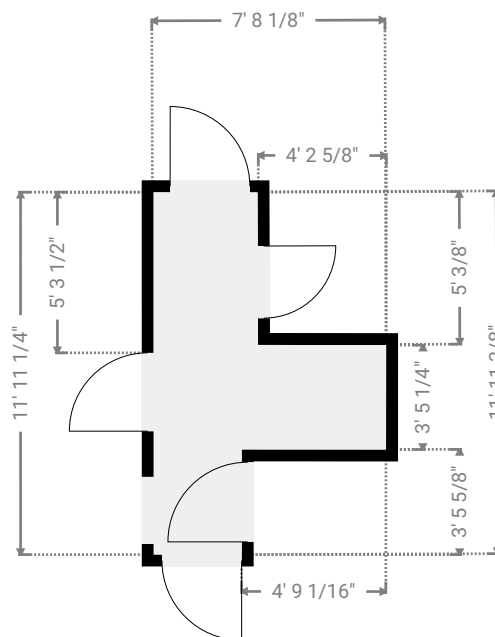
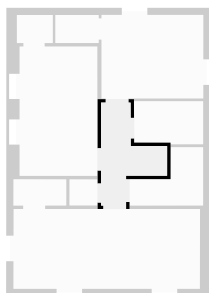

▼ **Closet**
2nd Floor

WIDTH: 3' 3 3/16" • LENGTH: 3' 3/8"
AREA: 9.88 sq ft • PERIMETER: 12' 6 15/16"

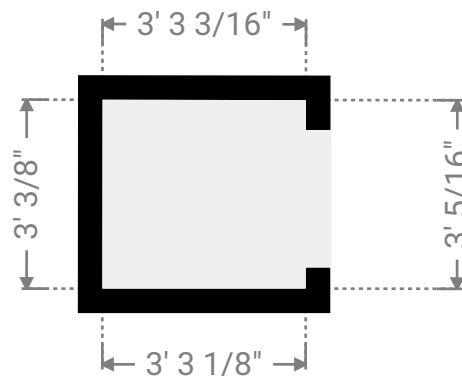
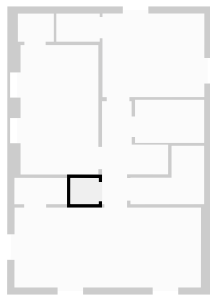

▼ **Stairway**
2nd Floor

WIDTH: 8' 6 1/2" • LENGTH: 6' 9 5/16"
AREA: 40.23 sq ft • PERIMETER: 30' 7 1/2"

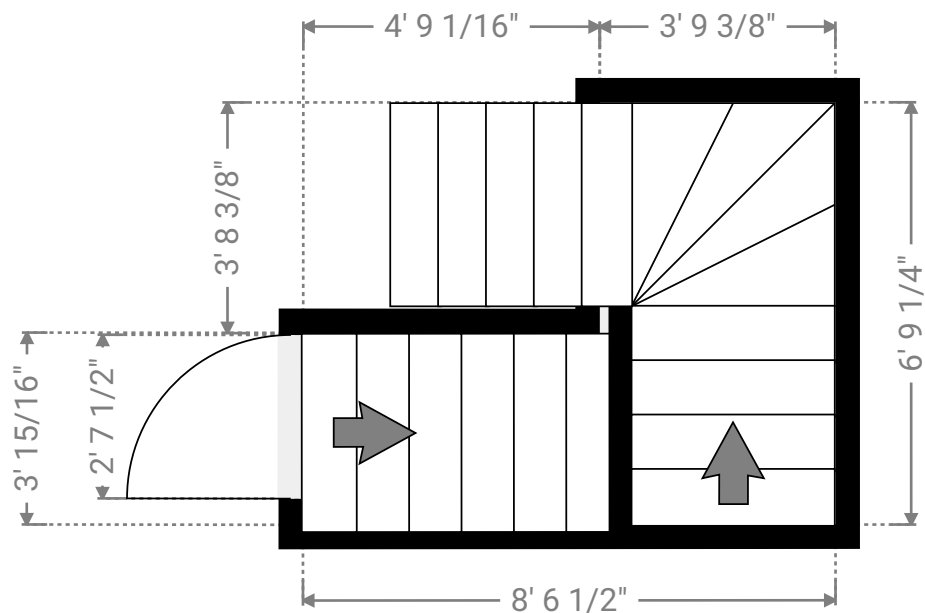
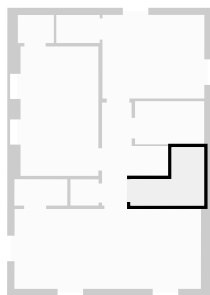

▼ 3rd Floor

TOTAL AREA: 362.82 sq ft • LIVING AREA: 362.82 sq ft • ROOMS: 3

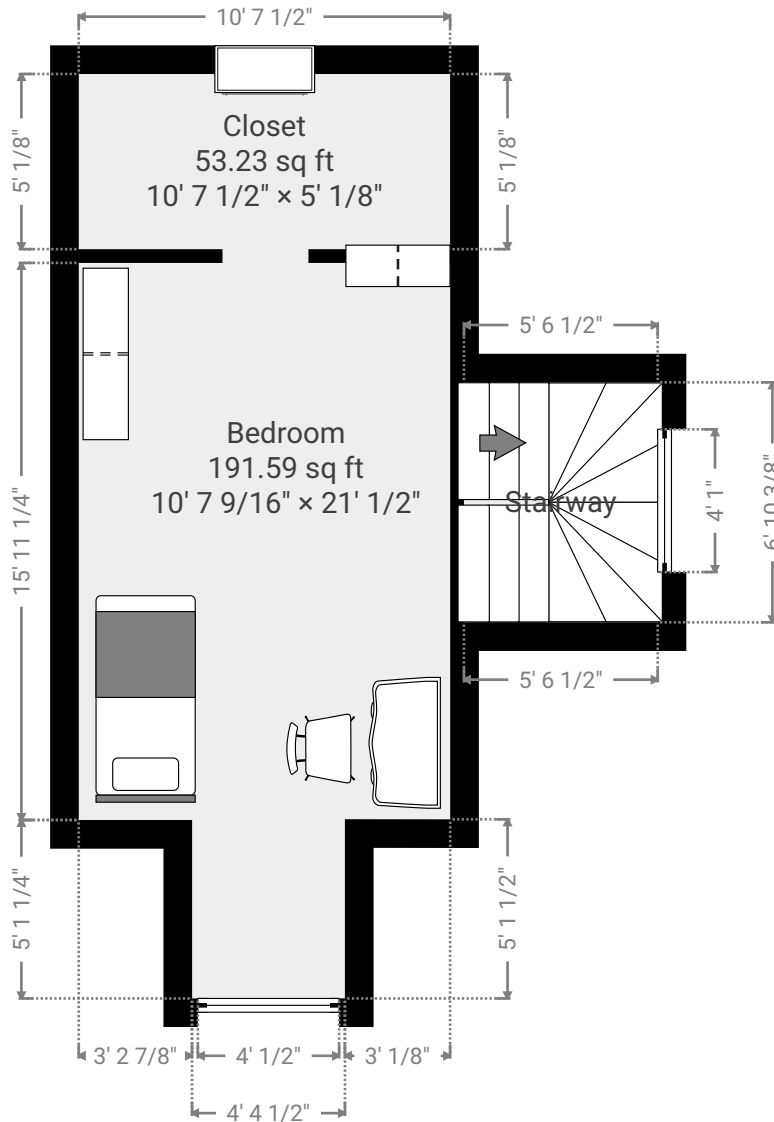

▼ **Bedroom**
3rd Floor

WIDTH: 10' 7 9/16" • LENGTH: 21' 1/2"
AREA: 191.59 sq ft • PERIMETER: 63' 4"

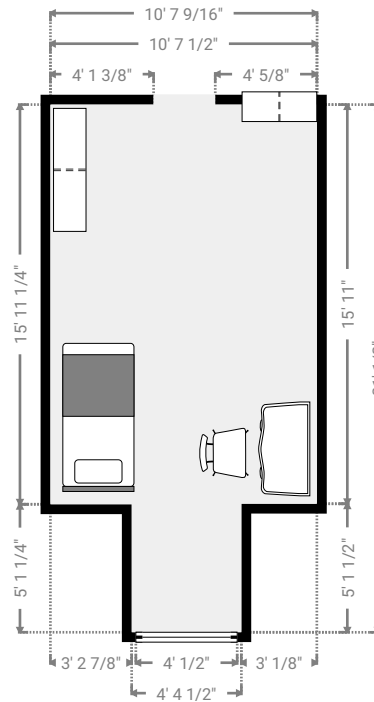
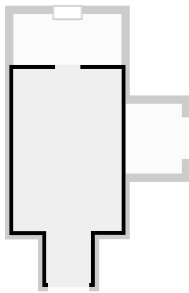

▼ **Closet**
3rd Floor

WIDTH: 10' 7 1/2" • LENGTH: 5' 1/8"
AREA: 53.23 sq ft • PERIMETER: 31' 3 3/16"

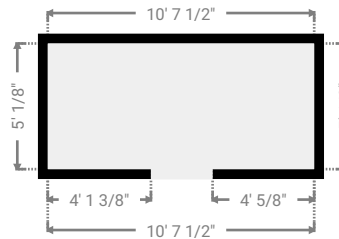
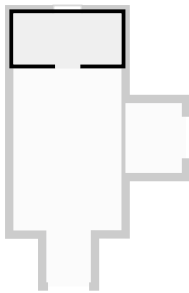

▼ **Stairway**
3rd Floor

WIDTH: 5' 6 1/2" • LENGTH: 6' 10 3/8"
AREA: 38.04 sq ft • PERIMETER: 24' 9 3/4"

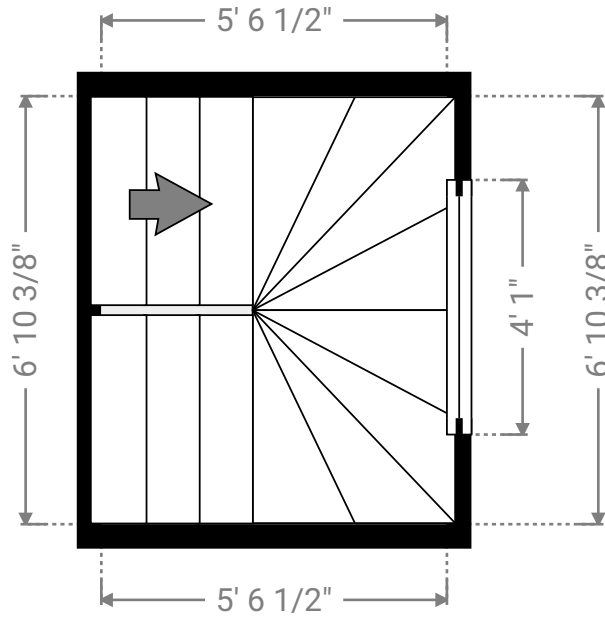
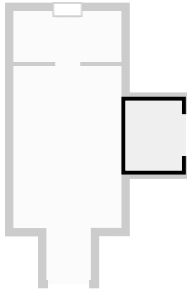

▼ **Basement • Level 1**

TOTAL AREA: 688.02 sq ft • LIVING AREA: 688.02 sq ft • ROOMS: 8

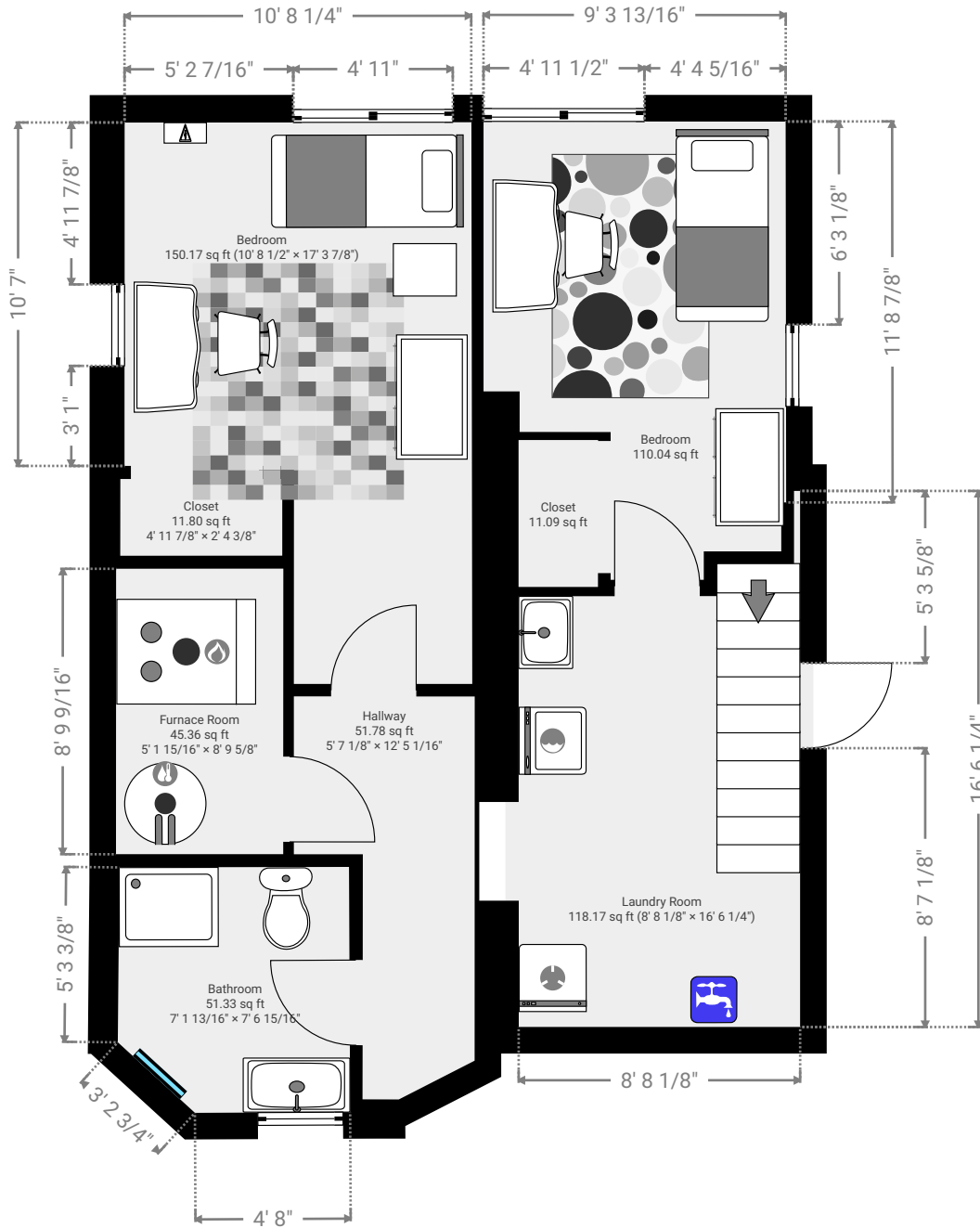

▼ **Bathroom**
Basement • Level 1

WIDTH: 7' 1 13/16" • LENGTH: 7' 6 15/16"
AREA: 51.33 sq ft • PERIMETER: 28' 3/8"

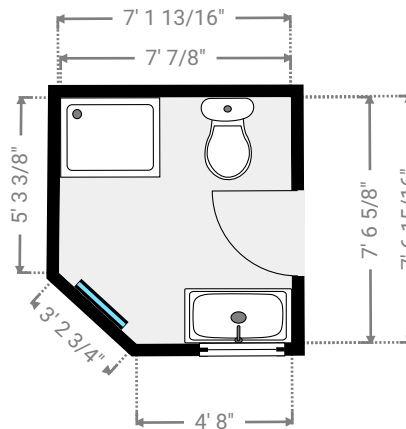
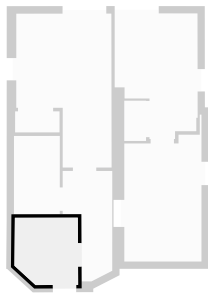

▼ **Bedroom**
Basement • Level 1

WIDTH: 9' 4" • LENGTH: 14' 1 9/16"
AREA: 110.04 sq ft • PERIMETER: 46' 10 13/16"

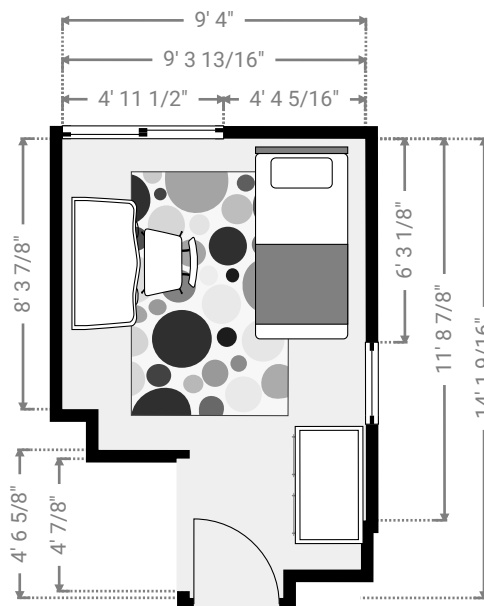
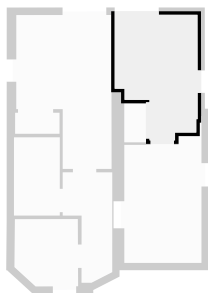

▼ **Closet**
Basement • Level 1

WIDTH: 2' 5 3/8" • LENGTH: 4' 6 3/8"
AREA: 11.09 sq ft • PERIMETER: 13' 11 7/16"

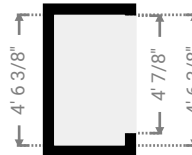
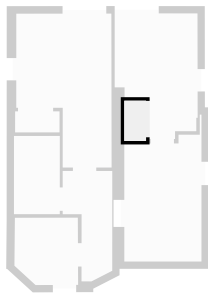

▼ **Bedroom**
Basement • Level 1

WIDTH: 10' 8 1/2" • LENGTH: 17' 3 7/8"
AREA: 150.17 sq ft • PERIMETER: 56' 1/4"

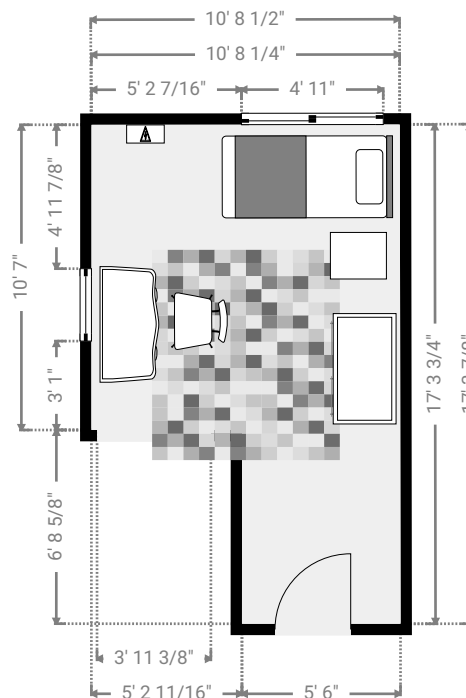
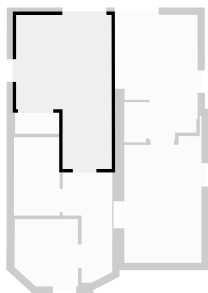

▼ **Closet**
Basement • Level 1

WIDTH: 4' 11 7/8" • LENGTH: 2' 4 3/8"
AREA: 11.80 sq ft • PERIMETER: 14' 8 9/16"

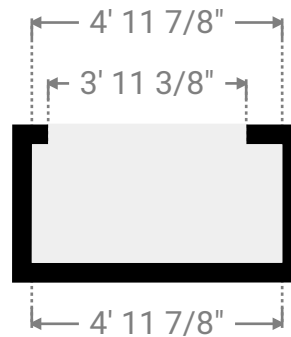
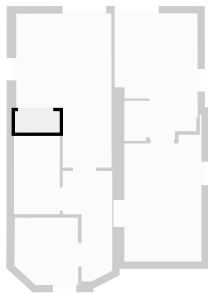

▼ **Furnace Room**
Basement • Level 1

WIDTH: 5' 1 15/16" • LENGTH: 8' 9 5/8"
AREA: 45.36 sq ft • PERIMETER: 27' 10 15/16"

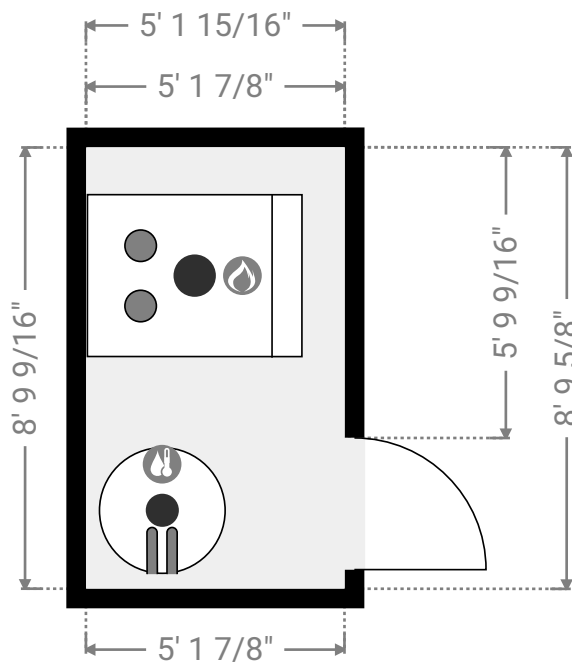
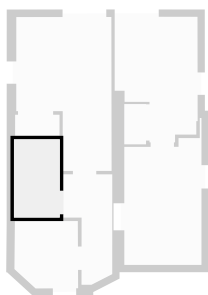

▼ **Hallway**
Basement • Level 1

WIDTH: 5' 7 1/8" • LENGTH: 12' 5 1/16"
AREA: 51.78 sq ft • PERIMETER: 35' 15/16"

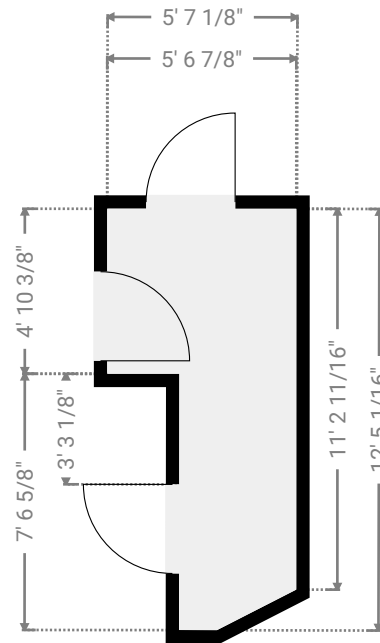
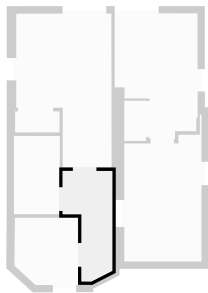

▼ **Laundry Room**
Basement • Level 1

WIDTH: 8' 8 1/8" • LENGTH: 16' 6 1/4"
AREA: 118.17 sq ft • PERIMETER: 50' 4 3/4"

