

530

CREATED ON
2022-12-26

Total area 1667.72 sq ft	Floors 3	Rooms 6	Bathroom 1
------------------------------------	--------------------	-------------------	----------------------

▼ 1st Floor

TOTAL AREA: 768.07 sq ft • LIVING AREA: 768.07 sq ft • ROOMS: 5

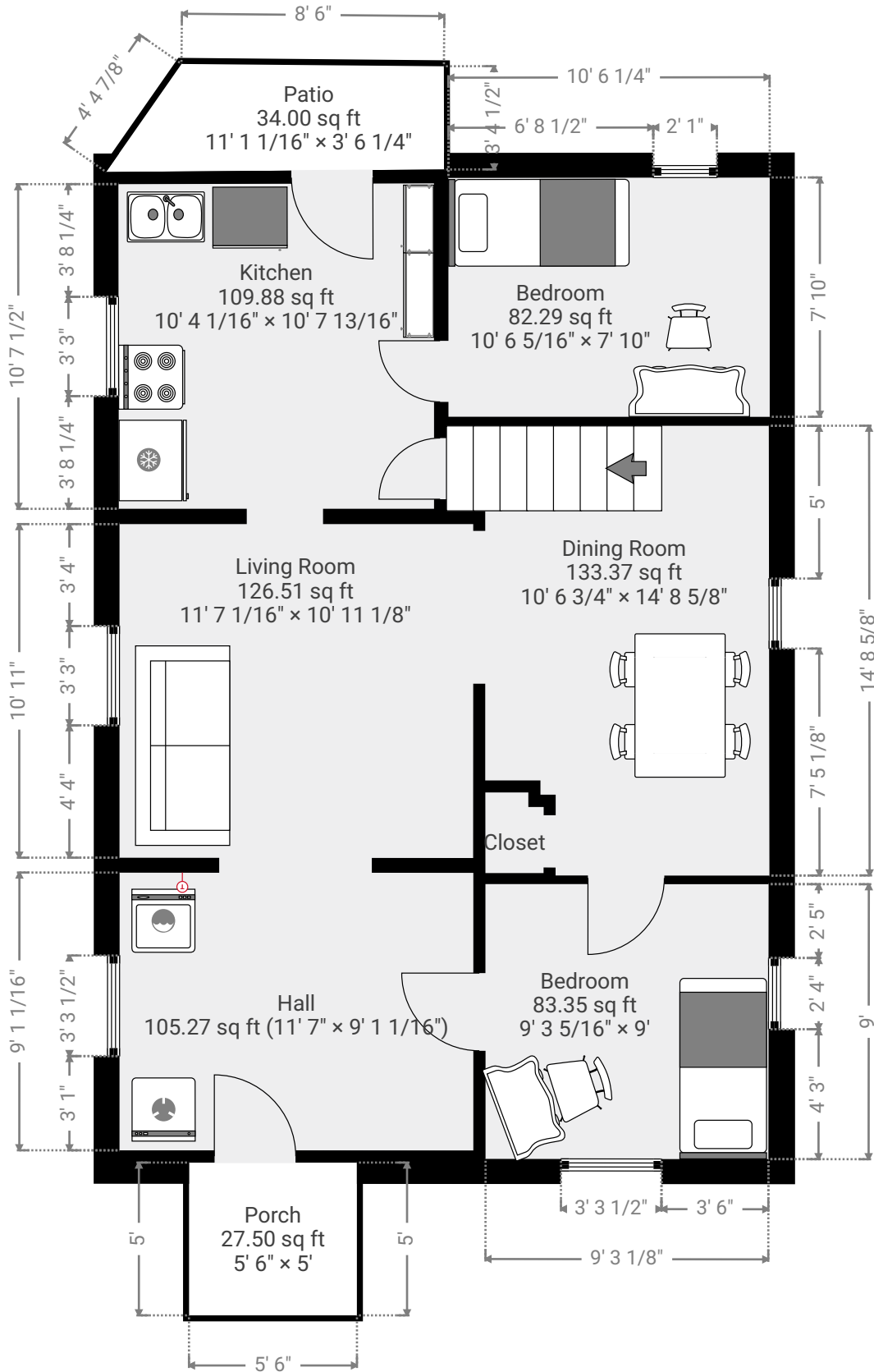

THIS FLOORPLAN IS PROVIDED WITHOUT WARRANTY OF ANY KIND. SENSOPIA DISCLAIMS ANY WARRANTY INCLUDING, WITHOUT LIMITATION, SATISFACTORY QUALITY OR ACCURACY OF DIMENSIONS.

▼ **Bedroom**
1st Floor

WIDTH: 10' 6 5/16" • LENGTH: 7' 10"
AREA: 82.29 sq ft • PERIMETER: 36' 8 3/16"

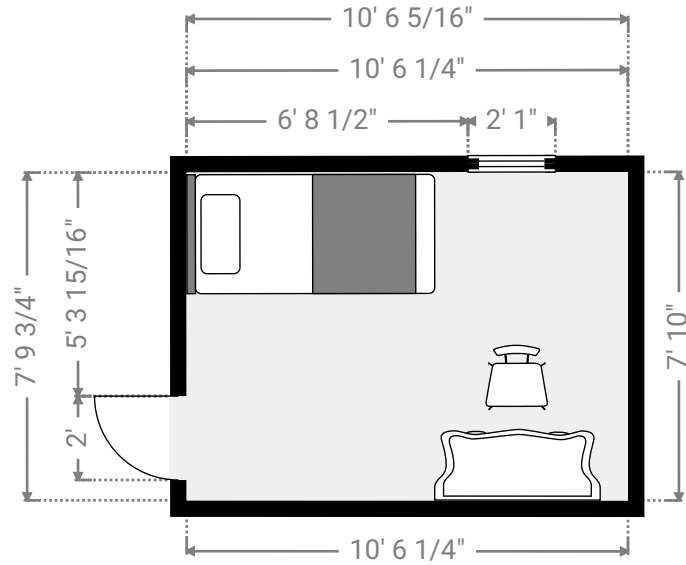
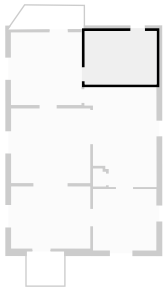

▼ **Bedroom**
1st Floor

WIDTH: 9' 3 5/16" • LENGTH: 9'
AREA: 83.35 sq ft • PERIMETER: 36' 6 5/16"

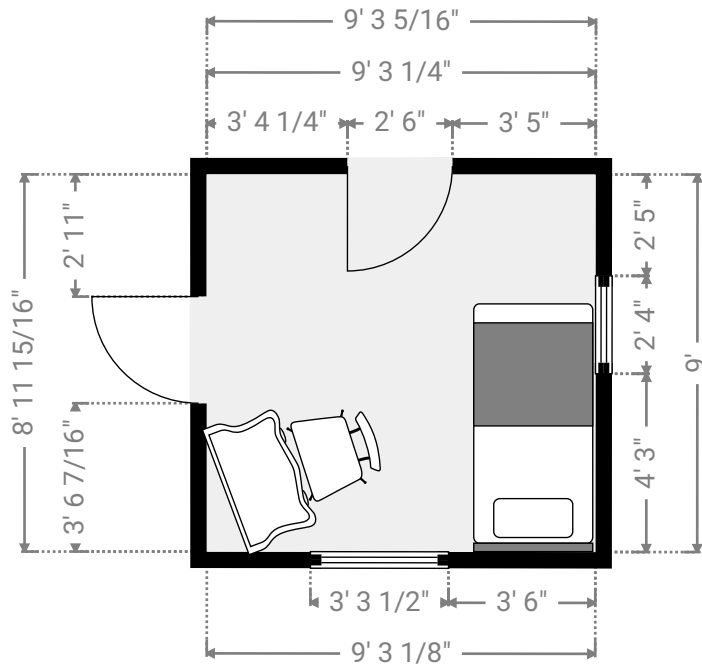
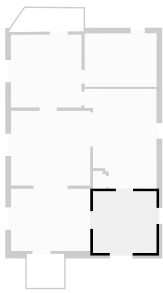

▼ Dining Room
1st Floor

WIDTH: 10' 6 3/4" • LENGTH: 14' 8 5/8"
AREA: 133.37 sq ft • PERIMETER: 50' 6 3/8"

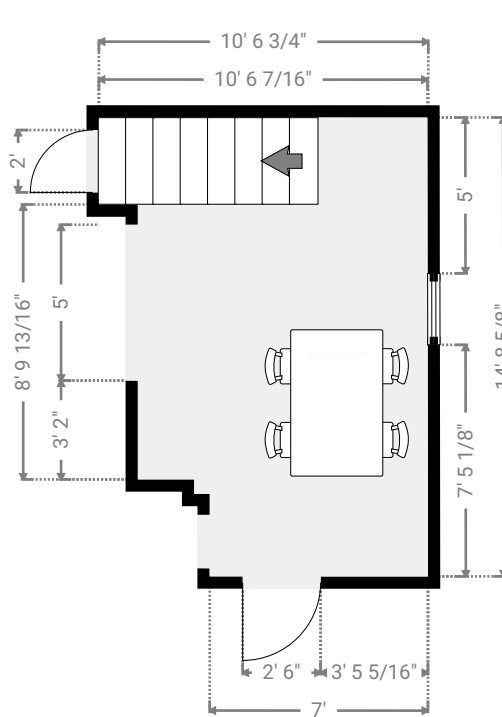
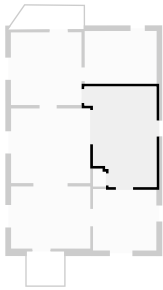

▼ Closet
1st Floor

WIDTH: 1' 10 7/8" • LENGTH: 2' 7 11/16"
AREA: 4.79 sq ft • PERIMETER: 9' 1 1/16"

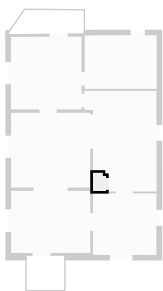

▼ **Hall**
1st Floor

WIDTH: 11' 7" • LENGTH: 9' 1 1/16"
AREA: 105.27 sq ft • PERIMETER: 41' 4 1/8"

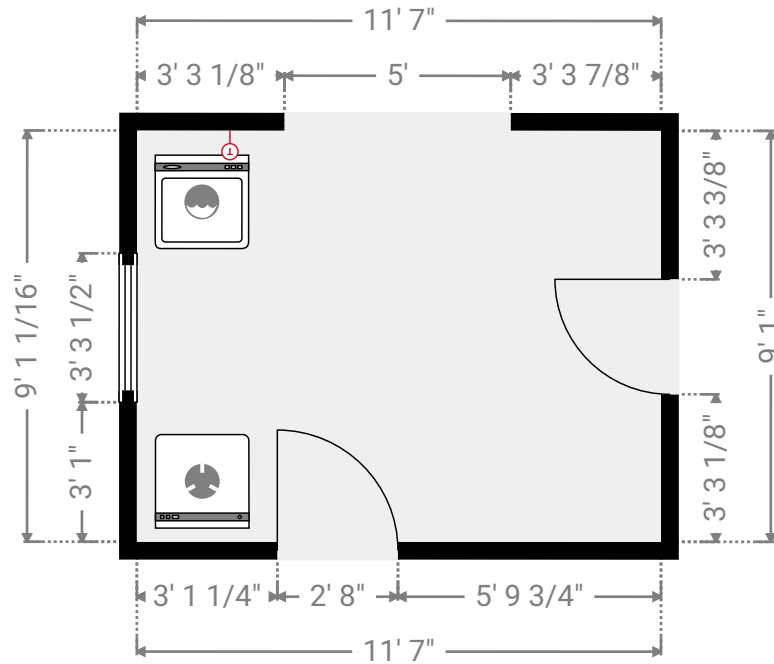
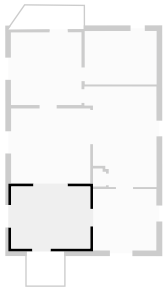

▼ **Porch**
1st Floor

WIDTH: 5' 6" • LENGTH: 5'
AREA: 27.50 sq ft • PERIMETER: 21'

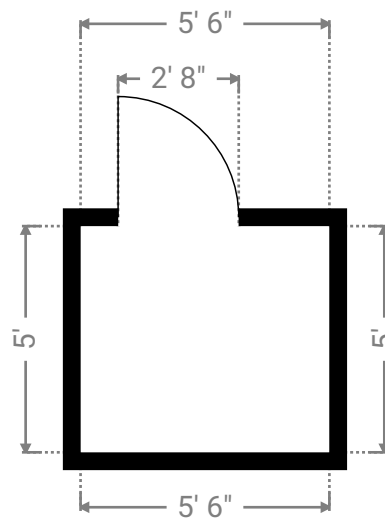
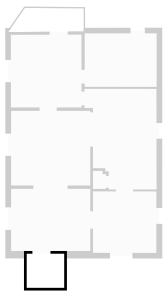

▼ Kitchen
1st Floor

WIDTH: 10' 4 1/16" • LENGTH: 10' 7 13/16"
AREA: 109.88 sq ft • PERIMETER: 41' 11 3/16"

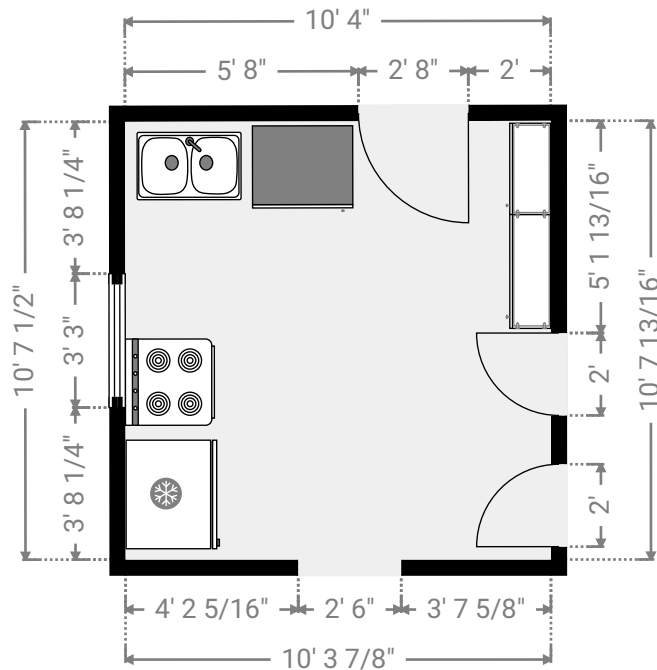
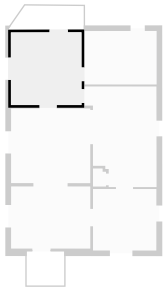

▼ Patio
1st Floor

WIDTH: 11' 1 1/16" • LENGTH: 3' 6 1/4"
AREA: 34.00 sq ft • PERIMETER: 27' 4 5/16"

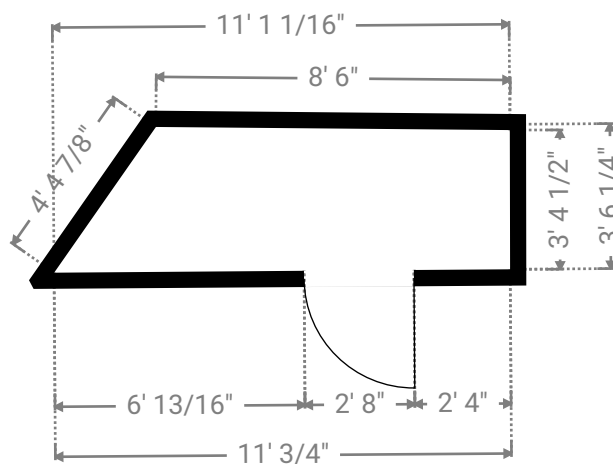
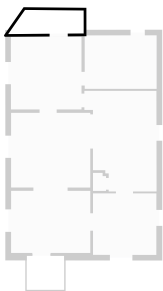

▼ Living Room
1st Floor

WIDTH: 11' 7 1/16" • LENGTH: 10' 11 1/8"
AREA: 126.51 sq ft • PERIMETER: 45' 1/8"

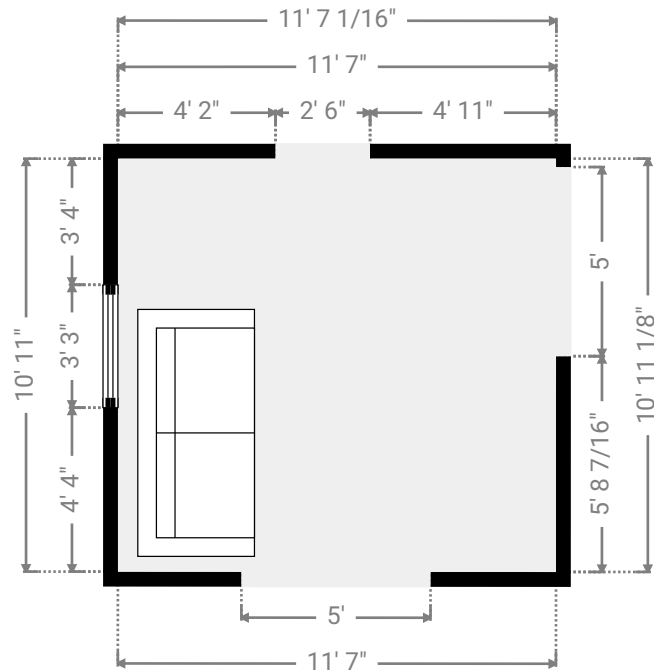
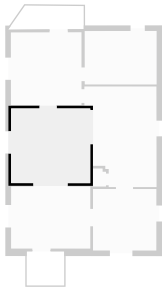

▼ 2nd Floor

TOTAL AREA: 300.43 sq ft • LIVING AREA: 300.43 sq ft • ROOMS: 1

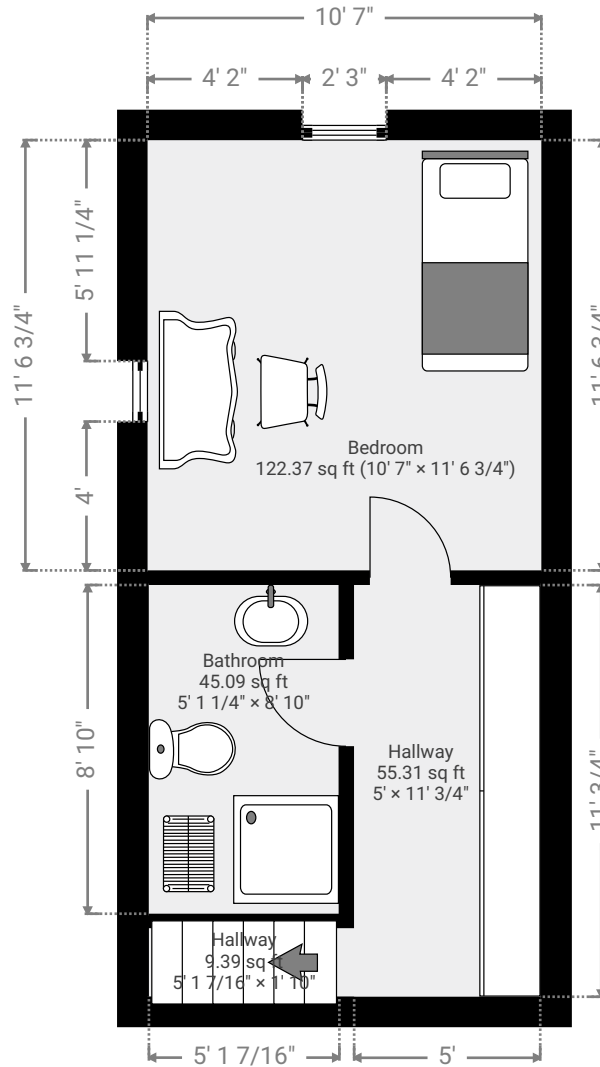

▼ Bathroom
2nd Floor

WIDTH: 5' 1 1/4" • LENGTH: 8' 10"
AREA: 45.09 sq ft • PERIMETER: 27' 10 1/2"

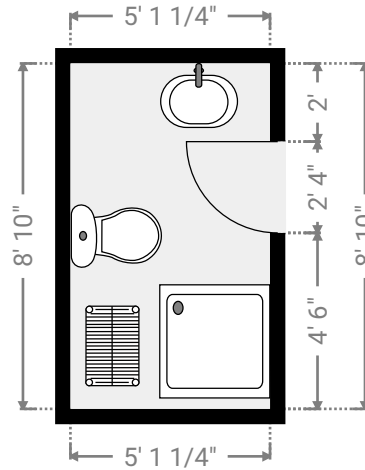
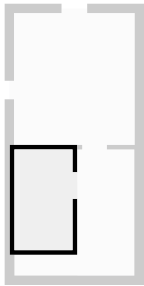

▼ Bedroom
2nd Floor

WIDTH: 10' 7" • LENGTH: 11' 6 3/4"
AREA: 122.37 sq ft • PERIMETER: 44' 3 1/2"

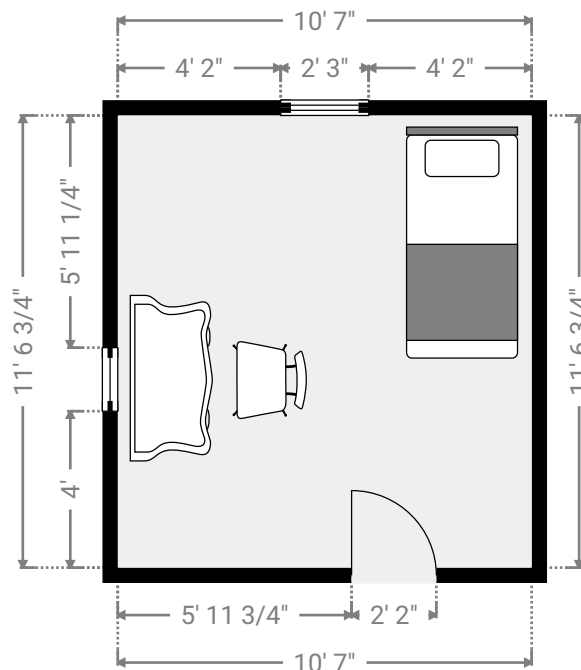
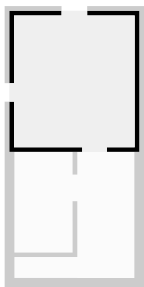

▼ **Hallway**
2nd Floor

WIDTH: 5' • LENGTH: 11' 3/4"
AREA: 55.31 sq ft • PERIMETER: 32' 1 1/2"

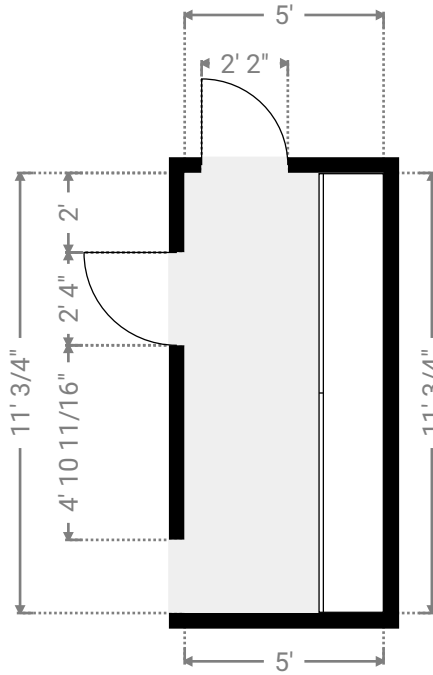
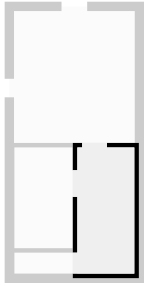

▼ Basement • Level 1

TOTAL AREA: 599.22 sq ft • LIVING AREA: 599.22 sq ft • ROOMS: 0

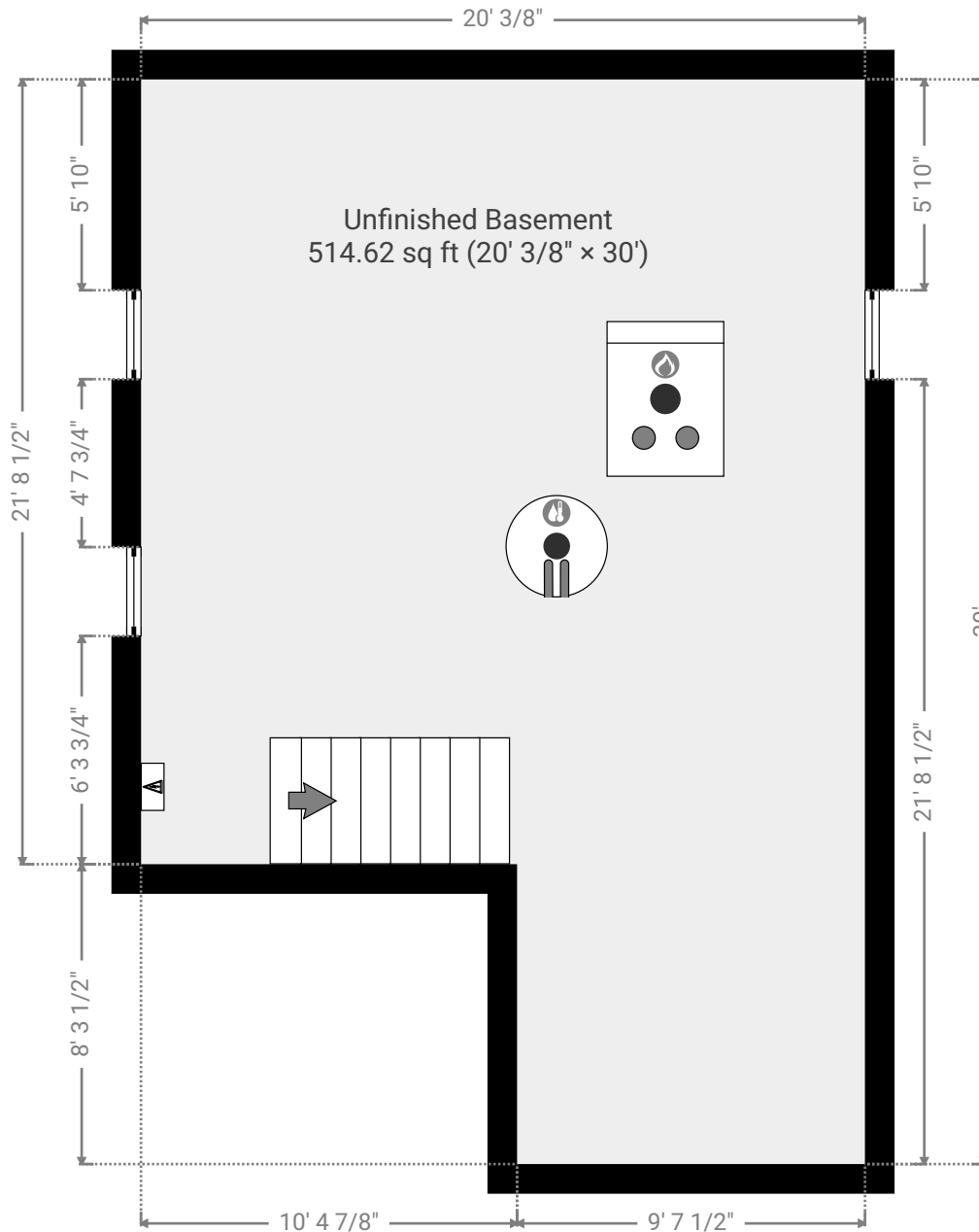

▼ Unfinished Basement
Basement • Level 1

WIDTH: 20' 3/8" • LENGTH: 30'
AREA: 514.62 sq ft • PERIMETER: 100' 3/4"

